

Renaissance Bicycle Company eZee Kit Installation Guide



The eZee electric bicycle conversion kit contains a hub motor, rechargeable battery, and all the other components required to bring electric power to your ride. Installation requires basic bike tools and takes between 30 minutes and 2 hours.



eZee Kit Installation Guide Version 2.0

Copyright © 2008 Renaissance Bicycle Company
www.ebikes.ca

Key Electronic Parts of Your System

Motor Controller

The Controller interfaces all the electrical components of your ebike and regulates the power of your motor

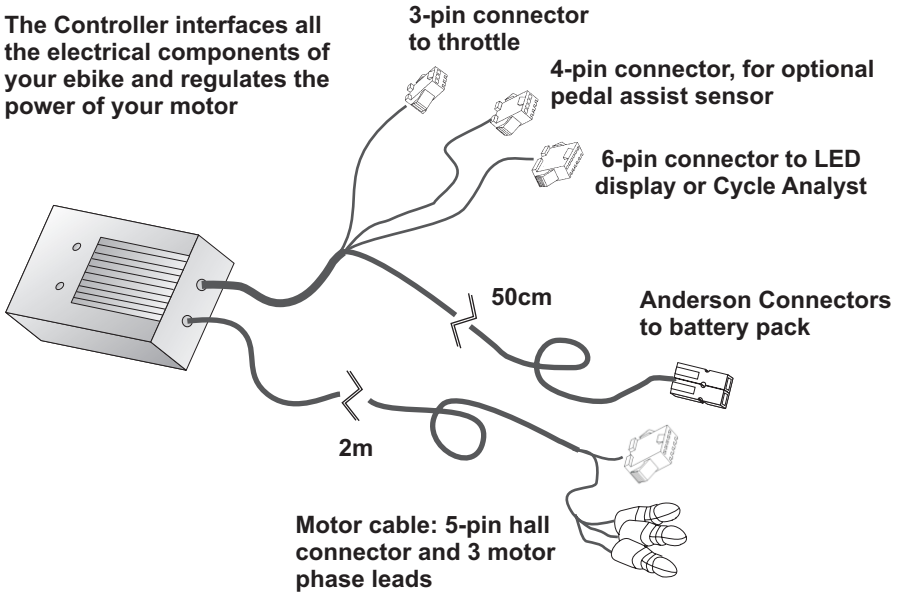

Throttle

The throttle controls the level of your motor assistance from your hand grip

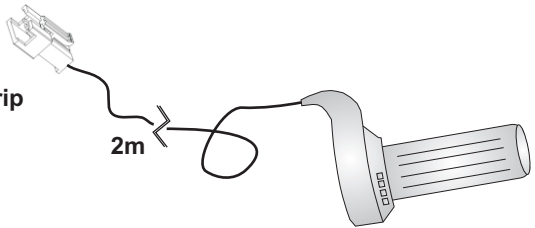

LED Indicator

Green, yellow, and red lights indicate battery voltage level

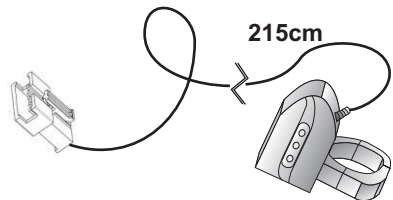

Hub Motor Installation

Install with disc

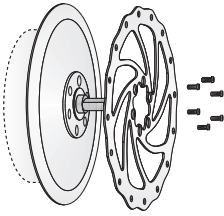

Install disc rotor onto hub motor using screws provided

Installation without disc

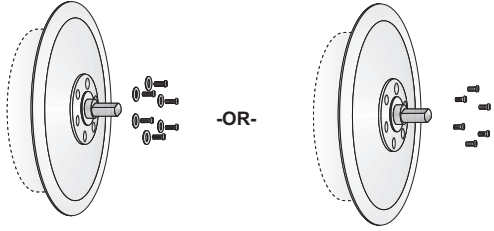

If disc not required, then depending on supplied hardware either a) install washers under set of xmm screws or b) install shorter xmm set of screws

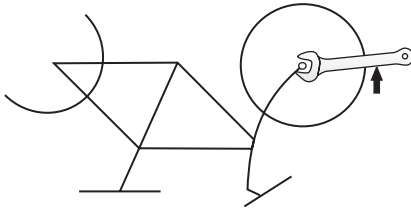

Remove original front wheel from bicycle

Insert the hub motor wheel into the front fork, ensuring that it is properly seated in the dropout slots

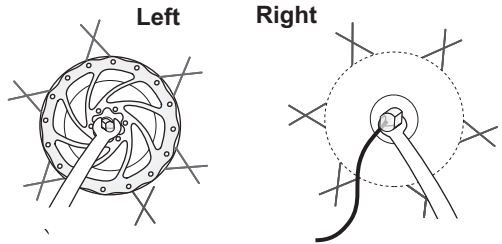

Tightening Assembly

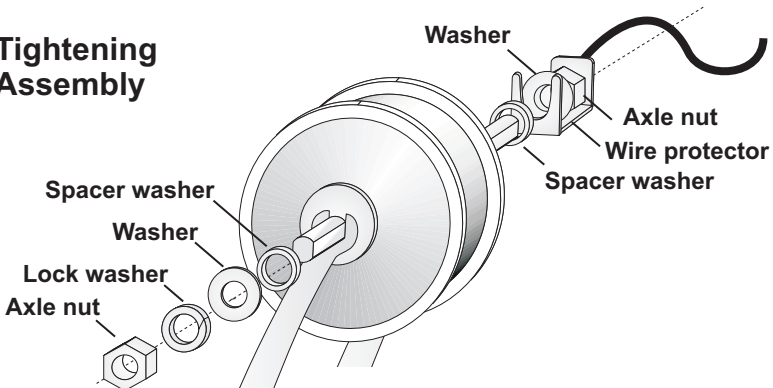

Securing and aligning the axle hardware

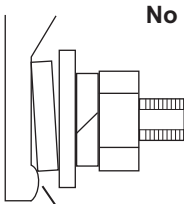
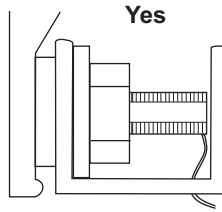
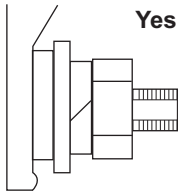

Spacer washer doesn't fit in quick release recess, requires filing the dropout

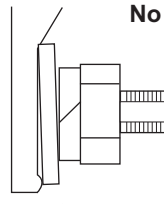

Spacer washer missing and large washer not sitting flat because it is hitting a quick release lip

Tightening assembly must sit flat

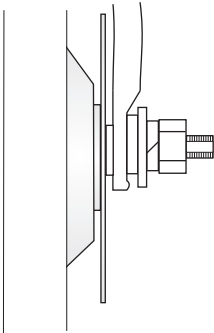

Side view with disc rotor

Tighten your axle nut firmly so the axle does not spin out and your wheel does not fall off (approx. 50 Nm)

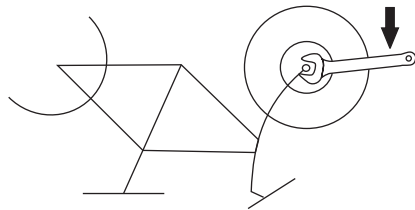

Normal Axle

Axle spin out: undesirable

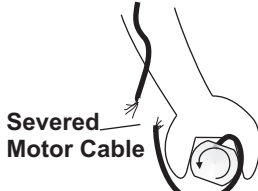

Axle spinout can happen if nut is not adequately tightened, washer stack does not sit flat, or axle is not properly seated

Dropouts splayed open

Motor Controller & Battery

Option 1: Controller inside battery bag

Shift to rear to avoid foot collision

Battery bag hangs on rear pannier rack

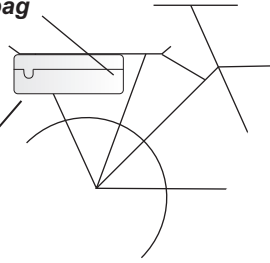

- OR -
If you plan to ride in hot weather, without pedaling up steep hills, etc., mount your controller outside of the battery bag to prevent thermal shutdown

Option 2: Controller mounted on front of rear pannier rack

Shift to rear to avoid foot collision

Battery bag hangs on rear pannier rack

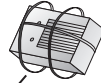
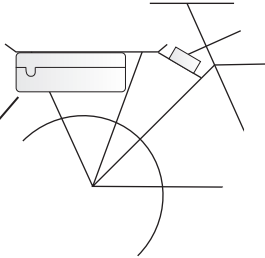

Use cable ties to fasten controller to rack

Throttle

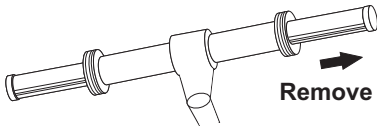

Remove original hand grip

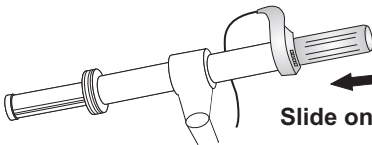

Slide on ebike throttle

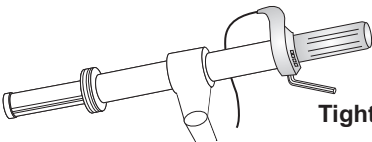

Tighten set screw with Allen wrench

Install twist throttles by replacing hand grip with throttle regulators. For bicycles with twist grip shifters, a thumb lever throttle may be preferred.

Handlebar display

Mount LED Display or Cycle Analyst on Handlebar

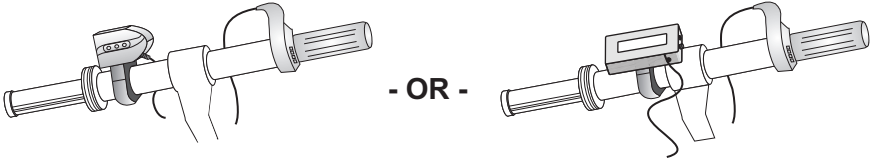

Standard eZee Kits include an LED battery indicator. The Cycle Analyst upgrade option provides more detailed information on your ebike dashboard and uses the same connector.

If your Cycle Analyst was purchased as an upgrade option, the configuration settings are correctly set; if your Cycle Analyst was purchased separately, adjust your configuration settings according to the specifications section on page 10.

Wiring

The electrical components of the eZee kit have all been terminated with mating and unambiguous connectors between the controller and each of the components. The throttle, battery pack, and motor must all be plugged into the motor controller for the kit to function. The display and pedal assist components are both optional.

Run ebike wires tidily along your bike frame and secure with cable ties: avoid over tightening so they do not sever

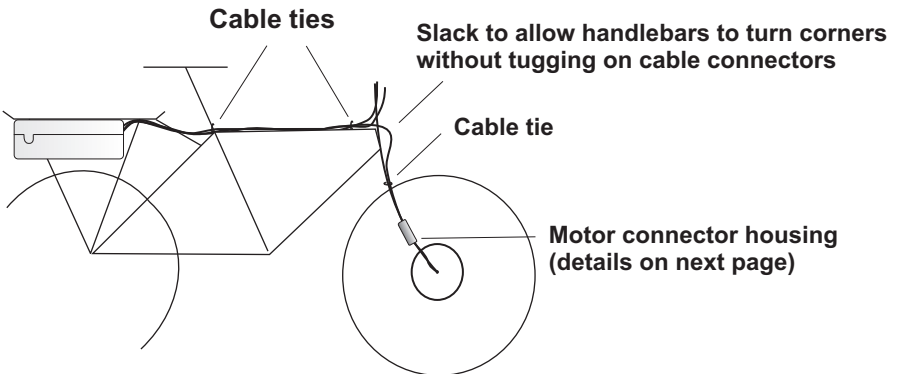

Attach connector case to front fork using cable ties

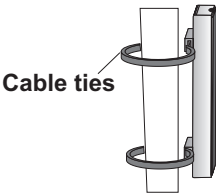

Connect bullet and hall connectors and place inside: match yellow, green, and blue wire colors

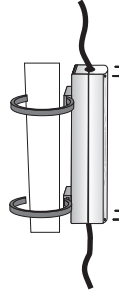

Wet weather tip: If you have exposed connectors that do not need to be unplugged, use silicone tape or heat shrink to wrap around the connections. This will prevent wet weather from corroding the contacts and reduces the chance of them getting tugged apart while riding.

Charging your battery

You can charge your battery any time, whether it is fully discharged or not. To use your charger, make sure the 110/220V switch on the back of your charger has been set correctly and then connect it to your wall outlet and battery. The LED indicator light will show orange when charging and takes about 5 hours for a full charge. When the charger has stopped charging it will show a green light.

The charger must be already connected to the battery pack when it is turned on in order to initiate a charge cycle. If the charger light is already green when it is plugged into the battery, it will not turn orange and start charging.

Store your battery fully charged and with its switch off. A stored battery must be charged once every 6 months because the battery self-discharges over time. Allowing the battery to completely self-discharge causes permanent damage.

Range and Speed

Using the supplied lithium battery, the eZee kit will provide a typical assisted range of 30 - 40 km. Under motor power only, the range is reduced to 15-20 km, while with judicious use it can stretched out to more than 50 km.

The speed of the motor is such that it will easily maintain 32 km/hr on the flats in the 26" wheel size. The 700c wheel size is slightly faster. The 20" eZee motor has been wound for a higher RPM so that it will also achieve 32 kph.

If the eZee kit is powered from a 48V battery pack, then the top speed will be increased by 30%, to just over 40 km/hr. Similarly, the speed can be reduced to about 20 km/hr by using a 24V battery. It is also possible to limit the speed to any particular value using the CycleAnalyst upgrade option.

Warranty

Warranty against manufacturing defects:

2 year warranty on eZee Kit motor and controller and 1 year warranty on eZee Battery and Battery Bag

FAQ

Q. How long will my battery last?

A. Your battery will maintain its capacity for about 500 cycles or two years of regular ebike use.

Q. My bike has suspension forks, can I install a hub motor?

A. The eZee hub can be successfully installed on suspension forks but adequately strong dropouts are required to withstand the forces on the axle slot. Either thick plate aluminum or Chromoly dropouts are recommended.

Q. Should I install a torque arm?

A. Torque plates are available for those who would like one, but are not required if your tightening assembly is properly installed.

Q. Why doesn't my charger light ever turn orange?

A. Your battery is not charging if your charger light does not turn orange. Check your connections and that the 110/220V switch on the back of your charger is set correctly.

Q. I stored my battery when it was flat, and now it is not charging, can I fix it?

A. It may be possible to recharge the battery bypassing the BMS, provided the cells have not been discharged below a critical voltage. The only way to know this is by opening the battery by a qualified individual opening the battery up and examining individual cell voltages.

Q. Which batteries can I use with my eZee hub motor kit?

A. Renaissance Bicycle Company eZee Kits will work with just about any 24, 36, 48V battery pack that can deliver 20Amps.

Q. I have twist grip gear shifters, or I am left handed, can I use another throttle?

A. Yes, our line of thumb, half-twist, and left-handed throttles are compatible with the eZee Kit.

Q. What is the pedal sensor option?

A. The pedal sensor disables the throttle when the rider is not pedaling and is available as an optional accessory. This enables compliance with Pedelec regulations in European and other jurisdictions.

Specifications

BATTERY

Voltage	37 V
Amp Hours	9.6 Ah
Charger Current	2A
Charger Voltage	42 V
Chemistry	Lithium Manganese
Weight	4.53 kg
Dimensions	37.5 x 7.0 cm

CONTROLLER

Max Voltage	60 V
Min Voltage	20 V
Waterproof	Yes
Current Limit	20 A
Weight	0.32 kg
Dimensions	9.8 x 6.5 cm

MOTOR

26"/700c K value	7.2 RPM/V
20" K value	9.1 RPM/V
Power at 36V	400 W
Power at 48V	550 W
Gear Ratio	5:1
Weight	3.72 kg

CYCLE ANALYST CONFIGURATION

Shunt Resistance	1.1 - 1.4 mOhm
Number of Poles	1
Iterm Max	4.5 V

Direct Plug-in Cycle Analyst configuration settings may need to be set if purchased separately

Connector Pinouts

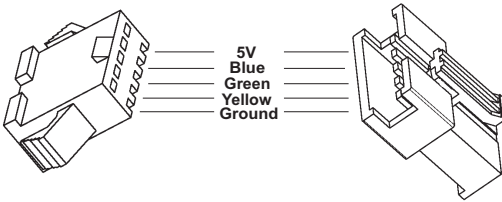

Hall Sensor

**LED Display/
Cycle Analyst**

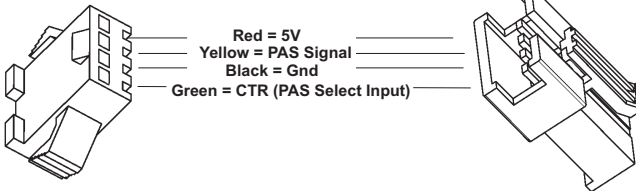
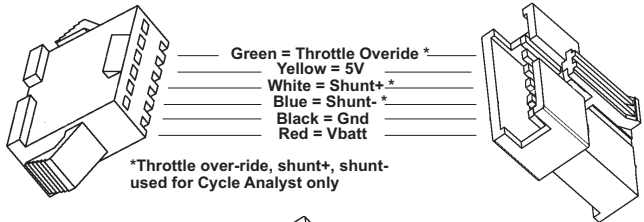

Pedal Sensor

Throttle

