

# 48V 10Ah eZee Flat Battery

## *Customized for Grin Tech*

## Specifications and User Guide

Rev 1.0

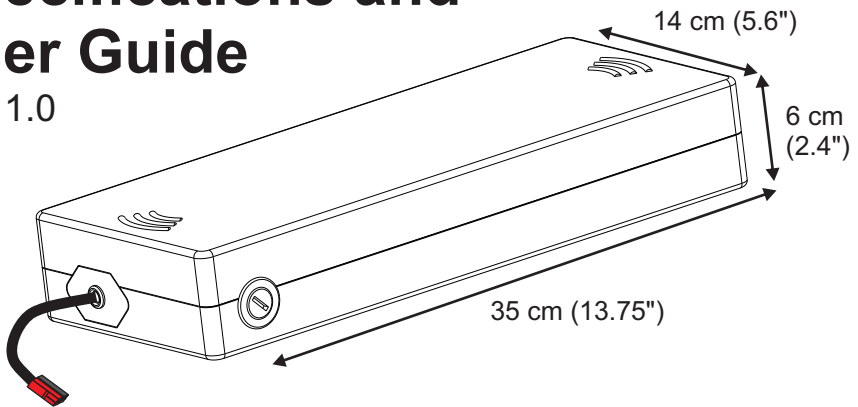

Written by:

**Grin Technologies Ltd.**

20 E 4th Ave

Vancouver, BC, Canada

V5T 1E8

ph: (604) 569-0902

email: [info@ebikes.ca](mailto:info@ebikes.ca)

web: <http://www.ebikes.ca>

**Copyright © 2012**

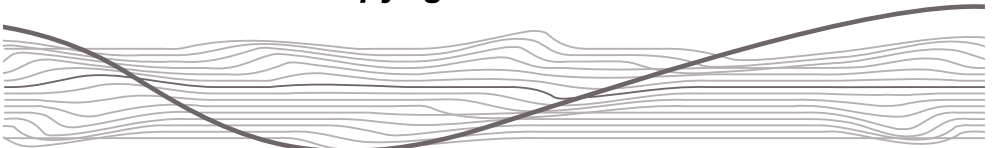

# 1. Introduction

Congratulations on your purchase of this 48V 10Ah lithium manganese ebike battery pack. Our hope is that it provides you with a solid 2-3 years of trouble-free power for your vehicle project.

## 2. Basic Usage

Rechargeable lithium batteries are easy to use. You use them as needed and charge whenever convenient. Unlike lead acid, they do not need to be topped up at every available opportunity in order to maximize their life, and unlike NiCad or NiMH, there is no benefit to periodically running a deep discharge on the pack for reconditioning.

**2.1. Discharging** The battery has a short cable terminated with red and black Anderson Powerpoles for plugging into your motor controller. In order for the battery to function, the ignition key switch must be inserted and turned all the way to the ON position.

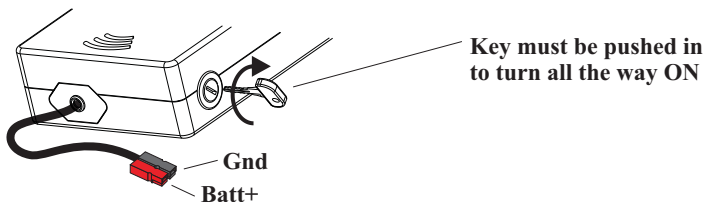

The discharge wires of the battery pack are protected by a Battery Management System (BMS) which will cutout if there is excessive current or if any cells are flat. However, the discharge port does not prevent overcharging either due to regenerative braking or charging up via a power supply, so caution is required if current is allowed into the pack by the discharge leads

**2.2. Charging** The battery is charged via a female 3-pin XLR charging port on the side of the battery.

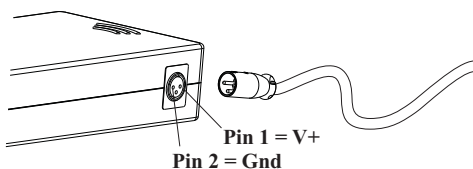

Charger output should be 54.5V, and no more than 4 amps.

The maximum recommended charge current for this style of connector is 5 amps. Even though the BMS will cut out the charging port once charged to prevent overcharging, it is important that the charger output does not exceed 54.5V. With a 3A battery charger, the recharge time for a flat battery is 3-4 hours.

**2.3. Storage** If the battery will be stored for any significant length of time, it is essential to at least partly charge the battery beforehand, and top it up every 4-6 months. It is also a good idea to turn the ignition key switch to the OFF position.

### 3. Important Safety Information

The danger of lithium battery fires has been widely reported and for good reason. An ebike sized lithium battery pack contains sufficient stored energy and volatile material that significant heat release and damage occurs if something goes awry. Even though some lithium chemistries such as LiFePO<sub>4</sub> and LiMn are reputedly 'safer' than other forms of lithium battery, none are 100%, and we have seen close calls and dangerous situations with all types.

Always assume the worst could happen and only charge the battery when you are around, or at the very least where any incident would be contained such as in a concrete garage. **Please don't leave your battery charging unattended in a place where a fire could result in loss of property or put people in danger.**

Similarly, you should not charge the battery from the discharge wires, as the BMS overcharge protection will not be functional, and you should not discharge the pack from the XLR charging port, as this can allow the cells to over-discharge.

## 4. Special Features

**4.1 Battery Rail Slide:** The underside of the battery has a pair of overhanging plastic rails that can slide onto the extrusion of a custom carrier rack. eZee produces both a seat post clamp and double decker rack with a compatible rail, while Grin manufactures a universal twist battery anchor that can attach to most 3rd party racks.

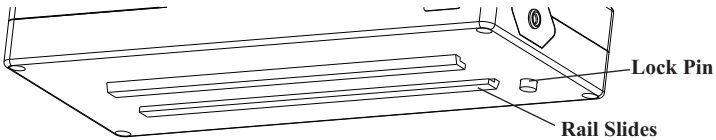

**4.2 Locking Key Switch:** The ignition key switch functions both as an electrical ON/OFF control and also as a physical lock for the battery. There are 3 positions, “open” retracts the locking pin completely so that the battery can be removed from the rail. “Off” still has the battery locked mechanically, while “On” both locks the battery and turns on the output port. You cannot remove the key from the “ON” position.

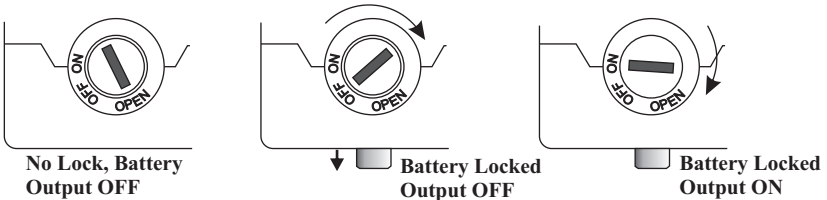

**4.3. BMS Port:** In addition to the 12 gauge red and black discharge wires, there is also a small signal cable coming out of the pack that is covered in shrinkwrap tubing. This is a communication port to the BMS circuitry, and enables pack diagnostic and troubleshooting without opening up the battery casing. A special I2C -> USB communication board is required to use this.

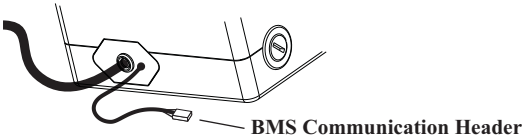

## 5. Additional Details

**5.1 Operation In Cold** Lithium batteries have a noticeable performance degradation at low temperatures (0°C and below). The available capacity is reduced and the voltage will sag more under load. There is no harm in running the battery at cold temperatures, but we recommend storing the battery indoors so that it starts off in a warmer state and thus can deliver better performance on the bike.

As well, you should not charge the battery at sub-zero temperatures, as the optimum charge voltage for a cold battery is less than a pack at room temperatures, and so you risk overcharging the pack. For instance, a LiMn battery charged to 42V in the freezing cold may rise to 44V when warmed up.

**5.2 Operation in Wet Weather** The solid eZee plastic enclosure provides good protection of the cells and circuitry from incidental water spray. However, the seams are not fully sealed and frequent exposure to rain and wet conditions can allow water ingress into the casing. Over time this can corrode the cell terminals and lead to erratic behaviour of the BMS circuitry. We suggest covering the battery with a bag when exposed to water spray.

**5.3 Flying / Travelling** Air travel regulations prohibit flying on passenger craft with lithium battery packs that have over 160 watt-hours of capacity, unless packaged to IATA standards as Class 9 dangerous goods. If you plan to travel with your ebike, you will likely need to ship the pack separately to your destination using an appropriate courier service.

**5.4 Self Discharge in Storage** Although lithium cells have very low self discharge, the BMS protection circuit inside the battery pack does draw a little current at all times. This BMS current is small, but if the battery is already flat when initially stored, it will only take a few weeks or months for this small current to further drain the cells to the permanent shutdown threshold of the BMS, at which point the pack can no longer be charged or discharged.

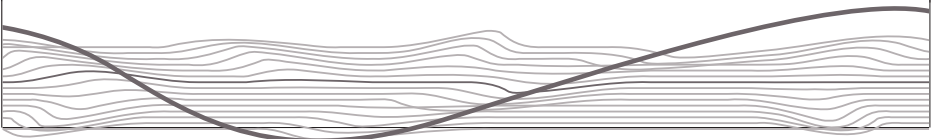

To prevent this from happening, be sure to periodically recharge the battery every 6 months while it is being stored.

If the battery is allowed to self discharge to the point of BMS shutdown, then the only way to recharge the battery is to open up the battery casing and trickle charge the cells directly, bypassing the BMS circuitry, until all cells are  $>2.7V$ . At that point, regular charging through the charge port is possible.

If the pack was allowed to self discharge to the point that some of the cells are less than  $1.5V$ , then safe recovery is not possible and the battery should be recycled.

## **5.5 Battery Longevity**

Battery cycle life is largely correlated with how much discharge current the pack has to deal with. Heavy and routine usage at high currents ( $>20A$ ) will generally shorten the lifespan of a pack. The lower your average current draw from the battery, the less it will be stressed and the more cycles you will get.

This is a continuous relationship, not a hard cutoff. For instance, a particular battery might deliver 600 cycles at  $10A$ , 400 cycles at  $20A$ , and only 250 cycles at  $40A$ . Batteries also have a calendar life that causes them to degrade over time whether being cycled or not. So for those wanting to maximize their milage from the pack, it is best to use it regularly but at only modest power levels ( $<25A$  for this  $48V$   $10Ah$  pack). Higher temperatures also reduce the battery life.

For typical ebike riders, the pack will still be performing quite well after 2 years of regular use, but by the 3rd year will generally be ready for replacement. As a battery ages, you will notice more voltage sag under load and less and less available capacity. If it suddenly stops working altogether, that is usually a wiring or BMS issue, not an end-of-life issue.

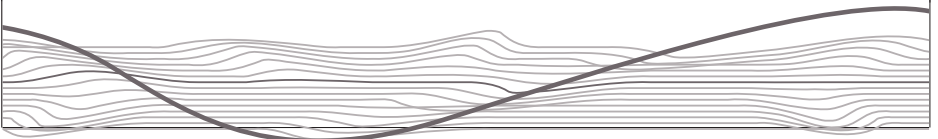

## 6. Basic Troubleshooting

If the battery is not providing any voltage to the ebike, then it is usually because the BMS circuitry has tripped or there is a break in the discharge wiring. Use a multimeter to measure the voltage on the discharge port, and also between pins 1 and 2 on the XLR charging port.

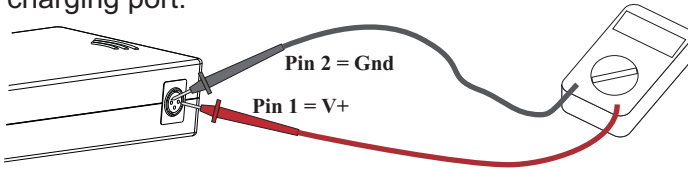

Discharge Wire	Charge Port	Possible Causes
~0V	40-54V	<ul style="list-style-type: none"><li>• Key Switch is OFF</li><li>• Key Switch is Broken</li><li>• Individual Cell &lt;2.5V</li><li>• Water Damage</li><li>• Blown Output Fuse</li></ul>
0-20V	<38V	<ul style="list-style-type: none"><li>• Pack is at critical low voltage shutdown from BMS self discharge</li></ul>
-	0V	<ul style="list-style-type: none"><li>• Blown Charge Fuse</li></ul>

It is normal that the pack capacity will gradually degrade over time. However, if this seems to happen suddenly, it could be either because some cells have become unbalanced, or the charger output is not giving a full charge to the battery pack. Always check that after a full charge your battery is at least 54V.

## 9. Disposal

Dead batteries can be returned for recycling through the Rechargeable Battery Recycling Corporation (RBRC). See their website for a map of nearest drop-off locations

<http://www.call2recycle.ca/>

# 10. Specifications

<b>Weight</b>	3.82 Kg
<b>Dimensions</b>	348 x 141 x 59mm
<b>Cells</b>	Samsung ICR18650-22P LiMn Power Cell
<b>Typical Capacity</b>	10.4 Amp-Hours (13S x 5P)
<b>BMS Type</b>	Programmable OZ890 with Bleed Balancing
<b>BMS Current</b>	< 200uA Operational, < 20uA Sleep
<b>Max Discharge Amps</b>	40A ( <i>25A recommended for good cycle life</i> )
<b>Max Charging Amps</b>	5A
<b>Full Charge Voltage</b>	53.5 - 54.5V
<b>Internal Resistance</b>	165 mOhm

# 11. Discharge Curves

